



TA003 TORQUE ARM AND CROSS-MEMBER INSTALLATION INSTRUCTIONS

Please take note before proceeding with this installation:

- *This product may interfere with certain exhaust kits. Exhaust crossovers are not compatible with this torque arm suspension. In some circumstances, it may be necessary to fabricate a custom exhaust for proper clearance.*
- *While not necessary, a heavy duty cast aluminum differential cover is recommended with this kit. These covers are more structural in nature than the stamped steel OE unit and will distribute the load across the differential, further strengthening the assembly.*

TOOLS REQUIRED:

3/8" and 1/2" drive ratchets
1/2", 9/16", 3/4", 15/16" and 1-1/8" sockets
Pry-bar
3/8" Allen wrench

ADDITIONAL ITEMS REQUIRED:

RTV gasket silicone
Gear oil

CROSS-MEMBER INSTALLATION:

- 1) Lift the vehicle and support with stands under the rocker panel pinch seams (Do not place stands under the subframe).
- 2) Remove the exhaust system.
- 3) Using a 15/16" socket, remove the rear two body mount bolts.
- 4) Remove the OE rubber body mount bushings. They are composed of an upper and lower bushing that "sandwich" the subframe together in the middle.
NOTE: it may be necessary to use a pry-bar to lower the subframe enough to remove these bushings.

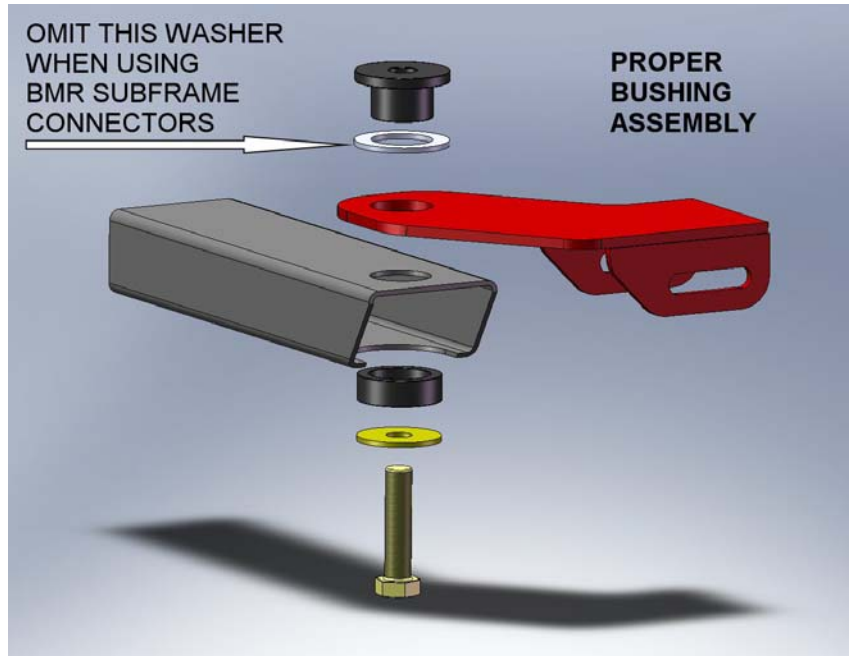

- 5) Once the OE bushings have been removed, inspect the subframe for rust damage. This is a common area susceptible to rust and if the mounting point is compromised, it needs to be repaired before proceeding with the installation.
- 6) Begin with the driver's side. Assemble the driver's side frame mount, billet body mounts and washer (if necessary) as shown in **Image 1**. If you are using BMR subframe connectors or any subframe connector that mounts around the body bushing, omit the supplied aluminum spacer washer shown in **Image 1** above.



CROSS-MEMBER INSTALLATION (Cont.)

- 7) Thread the supplied 5/8" bolt, washer and lock washer into the body and snug the bolt just enough to allow the frame bracket to rotate around the axis of the bushing.
- 8) Repeat steps 4-7 for the passenger side. At this stage both mounts should be installed and you can mount the cross-member. Lift the cross-member into place and insert the supplied 1/2" x 4.5" bolts, (8) stainless washers, and nuts.
- 9) Tighten the body mount bolts to 150 ft/lbs.
- 10) Center the cross-member to the driveshaft then tighten the (4) cross-member bolts.

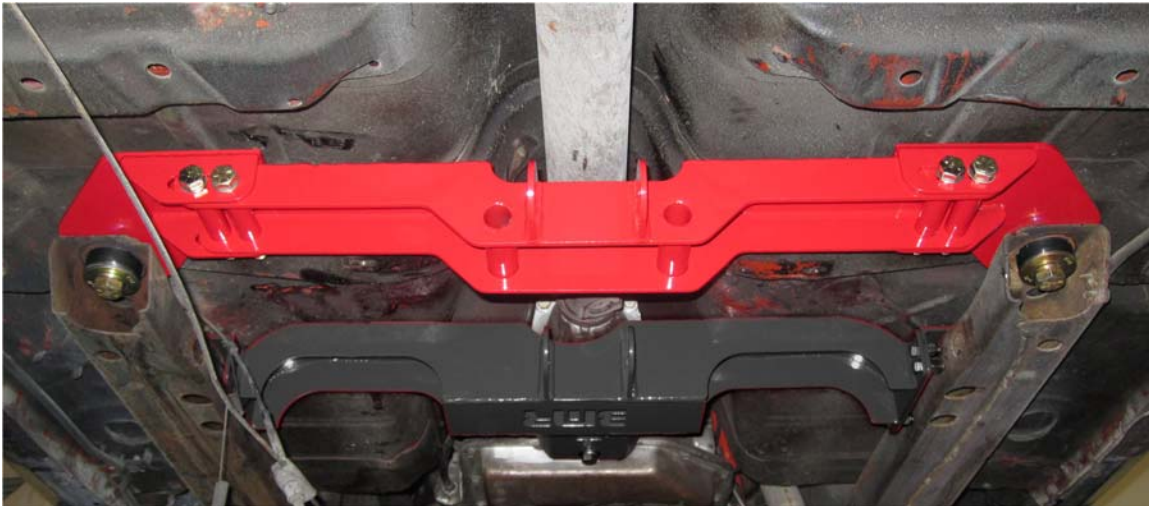

TORQUE ARM INSTALLATION INSTRUCTIONS:

- 1) Remove the differential drain plug or loosen the cover bolts to drain the gear oil from the differential.
- 2) If it was not necessary to remove the cover previously, remove the 12 bolts from the differential cover and remove the cover.
- 3) Using a gasket scraper, remove all gasket material from the cover and the differential.
- 4) Thread the four supplied 5/16" studs into the differential at the four corners. All studs should bottom out and should thread in to the same depth. If not, run a 5/16-18 bottoming tap through the holes in the differential.
- 5) Apply a thin bead of RTV Black or Grey gasket silicone onto the differential gasket mating surface. Install one of the supplied gaskets.
- 6) Apply another thin bead of RTV on the exposed gasket surface. Position the BMR torque arm mounting plate onto the rear end with the torque arm mounting points facing forward as in **Image 1** above.





TORQUE ARM INSTALLATION INSTRUCTIONS (Cont.)

- 7) Apply another thin bead of RTV onto the BMR torque arm mounting plate at the gasket mating surface then install the other supplied gasket.
- 8) Apply another thin bead of RTV onto the exposed gasket surface then re-install the differential cover.
- 9) Place one of the supplied 5/16" washers and 5/16" poly-lock nuts onto each stud and then insert the (8) 5/16" bolts and washers into the remaining holes. Tighten all twelve in a criss-cross pattern. Snug each one first then torque them to 20-25 ft/lbs.
- 10) Mount the torque arm to the differential mounting plate using one of the supplied 1/2" x 3.25" bolts. Place a stainless washer under the nut and temporarily thread it finger tight. (See **Image 2**)
- 11) Insert the front telescoping bushing into the torque arm with the grease fitting pointing downward.
- 12) Lift the front of the torque arm up until the bushing hole lines up with the mount on the torque arm cross-member. Insert the supplied 1/2" x 4" bolt, nut and stainless washer. Tighten to 90 ft/lbs. (**Image 3**)
- 13) Using a 3/4" deep socket, slightly loosen the leaf spring mounts on the rear end. They should be loose enough to allow the rear end to rotate slightly.
- 14) Position one of the support braces up against the torque arm as shown in **Image 5**. Place a lock washer over two of the supplied 3/4" x 2" bolts and thread them into the support brace, through the BMR differential mounting plate. Leave the bolts loose.





TORQUE ARM INSTALLATION INSTRUCTIONS (Cont.)

- 15) Repeat step 18 for the other side.
- 16) Loosen the jack screw from the bottom side of the torque arm using a 3/8" Allen wrench. **(Image 6)** Loosen it as far as possible to provide clearance between the rear end and the torque arm. This will be adjusted in a later step.



- 17) Place large diameter washers over the supplied 1/2" x 3.25" bolts and insert them into the four holes on the torque arm. It is typical for these holes not to align properly and is necessary to use a pry-bar to pivot the rear end until all four bolts slide through. *NOTE: this step is somewhat difficult and it may seem that the parts do not fit together however all assemblies are pre-fit and tested before shipping to insure proper fitment.*

- 18) Once all four bolts are through the assembly, place another large diameter washer and a nut on each one and finger-tighten them.
- 19) Using a 1-1/8" socket, tighten the four 3/4" bolts on the rear of the differential mounting plate to 150 ft/lbs.

- 20) The following step involves setting the driveline angle. While this process is actually very simple, it is difficult to explain so we have provided detailed instructions and examples below. Driveline angle is the difference between the pinion angle and the driveshaft angle. Zero degrees means there is no angle and the pinion and driveshaft are straight as viewed from the side. If the angle is negative, the driveshaft and the rear-end will form a "V". If it is positive, the driveshaft and rear-end will form an "upside down ^". For street driving this angle should be between 0 and -3 degrees to promote long u-joint life.



Begin by placing the supplied angle finder on the rear BMR mounting plate as shown in **Image 7** and record the reading. Take your reading from the drivers' side of the car. Since the rear cover is 90 degrees perpendicular to the pinion, this angle represents the angle of the pinion gear minus 90 degrees. Now place the angle finder on the driveshaft (**Image 8**) and record the reading from the drivers' side of the car. This angle represents the driveshaft angle. The goal angle to reach is a 2 degree difference between the two recorded angles. For example, our test car used for these instructions had the following readings.



TORQUE ARM INSTALLATION INSTRUCTIONS (Cont.)

The rear angle on the differential mounting plate was 88 degrees. You need to subtract 90 degrees from this to get your pinion angle, resulting in -2. The driveshaft angle just happened to be at 0 degrees. The difference between these two angles is -2, right where we want to be. If your resulting angle is anywhere between 0 and -3, it is an acceptable angle. To adjust this angle you can use the jack screw located at the back of the torque arm to raise or lower the pinion simply by turning the screw (refer back to **Image 6**). The screw will



turn against the rear end, pushing it upward. If the angle is off excessively, use a pry-bar to rotate the rear end until the angle is close enough to use the jack screw.

- 21) Once the driveline angle is set, tighten all 5 cross-bolts to 90 ft/lbs.
- 22) Make sure the jack screw is touching the differential housing and then tighten the jam-nut located on the jack screw.
- 23) Re-tighten the leaf spring bolts.
- 24) Fill the differential with gear lube.
- 25) Grease both of the front grease fittings with a silicone or other synthetic based lube.

This product is an aftermarket accessory and not designed by the vehicles manufacturer for use on this vehicle. As such, Buyer assumes all risk of any caused to the vehicle/person during installation or use of this product.